



INSTALLATION AND MAINTENANCE OF

Ulma ECO 2 Premium 30 kW



Chapter	Table of content	Page
1.	Information	3
2.	Description	3
3.	Installation	4
4.	Electrical installation	8
5.	Start-up & Settings (menus)	8
6.	Maintenance of the burner	26
7.	Wiring Diagram	28
8.	Drawing	29
9.	Data – and service information	30
10.	Warranty conditions	30
11.	Information to the installer	30
12.	Test Record	31
13.	Installation certificate (Customer copy)	32
14.	Installation certificate (To be sent to ULMA AB)	33

ULMA AB Energigatan 11 SE - 512 53 Svenljunga, SWEDEN Phone + 46 (0)325-17680
E-mail: info@ulma.se

www.ulma.se

ULMA AB reserves the right to changes in details and specifications without a preceding message.

Information

- Keep this manual so that it is accessible to professionals and future needs.
- Read this manual carefully before putting the pellet burner into service.
- Follow the manual and its instructions carefully and do recommended management and maintenance.

Registration to the local building authority in your municipality

N.B.: At every change of heating system, the local building authority of the municipality has to be contacted and a so called "Construction Registration" is made.

Inspection

Heating plants installed today shall be inspected and approved by authorized inspector like the local certified chimney-sweeper. The local building authority in the municipality can inform you how this could work.

Important at installation

- Run the feed auger of the burner by itself until the pellets start to come in constant flow. This can be made by connecting the feed cable of the burner directly to the cable of the auger. Run the auger approx. 15min after the first pellets have reached the outlet on the auger.
- The auger shall have a max angle 45 degrees and not be below 43 degrees.
- We recommend that the length of the hose, between the burner and the auger, should not be below 500mm. The auger shall also be placed so that it sits a little to the side of the tipping chute of the burner, this to avoid that pellets can fall down into the burner if back burning would occur when the hose burns off as a part of the safety.
- Hose inclination must be more than 45 degrees, otherwise the pellets are stuck in the hose.
- At adjustment of the burner, the draft limiter should be adjusted after the draft conditions of the chimney.
- The feed cable of the burner shall be connected above the overheating protection of the boiler.

Sweeping

Chimney sweeping shall in accordance with the fire-protection law shall be made frequently during the year. This is made by your local chimney sweeper. Regular cleaning of heating surface of the boiler shall be made in a way so that good operating economy is obtained. Prepare sweeping by turning off the boiler at least a couple of hours before cleaning to minimize the amount of glowing ash.

Warning!

See to that the power to the boiler is turned off before the cover over the burner is removed and dismount cabling to the burner when the burner is removed from the boiler.

Maintenance agreement increases operation length and life of the burner

ULMA AB recommends subscription of annual maintenance agreement.

Change of wear parts

ULMA AB always recommends that wear parts, when needed, are being changed. Ulma can provide necessary spare parts.

Description

Ulma ECO 2 is intended to be mounted on a boiler and shall be fueled with 6-8mm wood pellets. The enclosed conveyor feeds the fuel from a separate storage. The integrated steering controls the burner via the temperature giver that starts and stops the burner automatically. The burner has a switch for on-and-off switch that sits on the right side of the burner. The burner is provided with a system that controls the supervision and controls the combustion. The burner is ignited with help of a hot-air heater when the boiler temperature goes below the pre-set thermostat setting. The start procedure is fully automatic in several steps to get a fast and almost smoke free ignition. To then stop completely when set max temperature has been reached. After a short cooling phase the burner stops and re-starts when the thermostat calls for more heat.

Construction

The construction and choice of material are made with a long life time in mind. The firing zone of the burner is made of stainless, acid proof and high temperature constantly steel. The burner is an overflow fed kind of

burner and equipped with compressed air cleaning.

Safety functions

Ulma ECO 2 fulfills all existing safety requirements and norms according to the Swedish National Housing Board. The burner is equipped with several, of each other independent, safety functions.

- The overheating protection on the tipping chute that turns off the burner when the temperature goes over 90°.
- The flame guard that has the supervision of the flame.
- The fall shaft that prevents contact between pellets and combustion.
- A third safety detail is the plastic feed hose between feed auger and burner. The hose melts off at too high temperature and thereby cuts off the pellet feeding to the burner.

Unpacking

At unpacking of the burner, make sure that all parts on the list below are there:

Pellet burner
Manual
Kit with mounting set
Fallhose

Installation

Ulma ECO 2 shall be mounted in one of the doors of the boiler. It is often suitable to mount it in the oil burner door, but if the space for ash is small the door for wood burning could be a good alternative. If the door is so small it can not be opened without removing the pellet burner, it can easily be removed and re-mounted with the enclosed mounting flange.

Mounting of the burner

1. Decide where on the boiler the burner should be mounted. If possible place it so that you can open the door with the burner still on, since that facilitates the operation.

N.B.! THE DOOR MAY NOT BE POSSIBLE TO OPEN WITHOUT THAT THE POWER TO THE BURNER IS SWITCHED OFF.

2. Mark out where the burner shall be placed and make a hole in the door, with for example a compass saw for metal. Mount the docking flange and pack with fireproof insulating mat or high temperature silicone, we do not recommend boiler cement. The sleeve coupling shall be mounted with the screw on the right side. Insert the burner and direct it up straight and tighten the screw. If possible, we recommend that you mount a fireproof board on the inside of the door that for example is fastened with a sheet-metal of approx. 1-2 mm in stainless. This makes you avoid radiant heat backwards towards the burner. See picture example to the right.
3. Make sure that all doors and dampers are packed, so that air can not enter. This is a disadvantage since it makes it more difficult to adjust the burner to optimal combustion since it is then leading to too high surplus of oxygen in the combustion and in turn a worse efficiency.
4. When the burner is mounted and possible packing of the boiler is made, the auger should be mounted. Fasten the auger with the enclosed chain in the ceiling. Before the auger and the burner are mounted together, see the start and settings chapter. **IMPORTANT! IF FLUE-GAS DAMPER EXISTS IT SHOULD ALWAYS BE OPEN. ALL DOORS AND FLUE-GAS CONNECTIONS SHALL BE PACKED.** This is extra important if the chimney is narrow or generates bad draft for another reason. Otherwise there is a risk for indention at start, especially if the burner is not correctly set.

Feed auger

The angle from the horizontal level shall be between 42 and 45 degrees. The feed auger has to be fastened well since it wants to work its way into the storage. The auger is hanged up in the front edge with the enclosed chain and fastened well in the ceiling. The feed auger should be placed so that it does not sit right above the tipping chute on the burner. This only to avoid that pellets can fall down into the tipping chute if back fire would appear and the hose burns off as part of the safety. The auger shall be removed from the storage at least once per year and be cleaned from chip wastes. Then re-mount the auger and connect the connection cable of the auger with the net cable of the burner and run it manually until pellets have been fed out from the auger in about 15 minutes. This to avoid air pockets that could cause uneven feeding. Also control the angle of the auger again.

Manufacturing of feed pipe from 75x3mm plastic pipe (Accessories, purchased separately)

The length of the plastic pipe should not be over 2m. That could bring uneven feeding. A shorter feed auger is always preferable. Then engine and adapter are required, The standard length of our spiral is 1,67 m . (Please see mounting example.)

Manufacturing and mounting example:



1. Get the metal inlet.



2. Get a 75mm plastic pipe from your local supplier.



3. Plastic pipe and metal inlet..



4. Fasten the plastic pipe and the metal inlet with the enclosed screw.



5. Get the auger engine.



6. Also the T-pipe that is enclosed in the kit.



7. Mount mounting plate & auger and thread the auger spiral against the engine.



8. Then thread back the auger spiral approx. 10mm. So that it does not go against the engine.



9. Fasten the outer binding screw.



10. Fasten the inner binding screw through the drilled hole.



11. The spiral mounted on the engine.



12. Push the plastic pipe together with the T-pipe in the opposite end you drilled the inlet hole in the plastic pipe.



13. The outlet hole on the plastic pipe should be 180 degrees towards the outlet on the T-pipe.



14. Fasten the plastic pipe with enclosed screw.



15. Auger pipe and T-pipe connected.



16. Push the auger pipe over the spiral and press on and fix it in place with the outlet of the T-pipe towards the side of the connector on the engine.



17. Fasten binding screw.



18. Assembled auger with hose mounted.

Boiler room & safety

There has to be an open air supply valve in the boiler room to give air to the combustion. The free surface of the vent should correspond to the cross section area of the chimney. A hot air furnace can not get the hot air from the boiler room! From a fire safety point of view it is important that the boiler room is clean and dust free. Combustible materials should not be stored closer than 1,5m from the burner. Chemicals should not what so ever be stored in the boiler room since they are often inflammable and can also cause risk of explosion. The door to the boiler room should always be closed so that the room can work as a fire cell.

Pellet storage

The storage should be designed so that there are no unnecessary dust and chips at filling to avoid problems like vaulting of the pellets. Therefore we recommend completed storages from MAFA i Ängelholm.

In cooperation with MAFA we can offer two models of week storages that we recommend MAFA MINI that holds 300 liters and MAFA MIDI that holds 730 liters. These storages are most suitable when using pellets in small bags. For houses and smaller real estates bulk deliveries is the most comfortable, effective and cheapest way to handle fuel pellets.



The suitability of the boiler

The Ulma ECO 2 can be installed in almost all existing boiler on the market. It is important that the hearth is so big that the flame does not touch water cooled walls. There should also be room for the ash. The smoke flues of the boiler may not be so narrow that they clog with ash. Wood boilers have the advantage that they often have larger room for the ash and are easier to sweep, but even most oil fired boilers are suitable for Ulma ECO 2. When choosing where to place it a double boiler, make sure if there is a big difference between the effect between oil and wood. If the difference does not go over 10kw, the pellet burner should be placed in the wood door if it is possible to open the door with the burner mounted. A boiler meant for high efficiency more than 40kw can give too low flue gas temperatures (see the chapter chimney).

The chimney

The chimney should be inspected and possibly test pressured before installation if it has not been operating before and had continuous maintenance from the local chimney sweeper. At smallest doubt contact your certified chimney sweeper for inspection. Please note that at too low flue gas temperature the flue gases may condense with risk of frost damages on the chimney as result. As a rule of thumb you should aim at a flue gas temperature of at least 70-80°C 1m down in the chimney when the burner is burning, this goes first of all for brick chimneys or similar material. The choice of flue gas temperature depends on the design and isolation, a steel chimney or walled chimney with flue lining tube are not as easily damaged of low flue gas temperatures, provided that possible condensate is drained continuously from the lowest point of the chimney. This is the task of the installer to control at the installation.

If the chimney is already equipped with a chimney damper this should be completely open at pellet firing. If possible lock this in some way in open position.

We recommend installation of draft limiter (Back draft door)

The draft limiter shall at installation be adjusted by the installer of approx. -0,10/- 0.15 hPa under pressure. The draft limiter also helps ventilate the chimney and minimize the risk of condensate problems. We recommend that it is mounted on the flue pipe out from the boiler. It should be placed so that flue gas measurements could be made before the draft limiter.

Flue gas thermometer

Provide your installation with a flue gas thermometer. Here you can easily see when the temperature rises and it is time to clean the installation. Suitable temperature rising is approx. 40-50 degrees. But you should also overlook the capacity of the boiler on hearth and convection part to take care of the ash amount in good time. The tighter intervals give better fuel economy and efficiency.

Flue gas analysis

At installation the unit should always be adjusted with a flue gas instrument and not only with help from the human eye. When the burner is in place and has been trimmed in with a flue gas instrument a print of the control measurements of the installer should be made. You should be able to read values like CO, O₂, CO₂, combustion efficiency, draft, flue gas temperature etc. This analysis should also be made in writing in the two forms that you find at the end of this manual. One of them you keep and one should be sent to ULMA AB in Svenljunga. If this is not followed the warranty part of the burner is not valid.

Goal values:

CO₂ : 11 %
CO : 10 - 300 ppm
O₂ : 8 – 10 %
hPa : -0,10 / -0,15 (draft)
Combustion efficiency (average): 90-92 %

Fuel quality

The burner can handle most kinds of wood pellets between 6-8mm. At change of pellet deliverer the burner should be adjusted with a flue gas instrument. We also recommend one flue gas analysis per year to have a better control over the combustion.

■ Electrical installation

All electrical connections on the burner and auger have high speed contact device see below

1. To temperature giver
2. To feed auger
3. Power lead in (230 v)

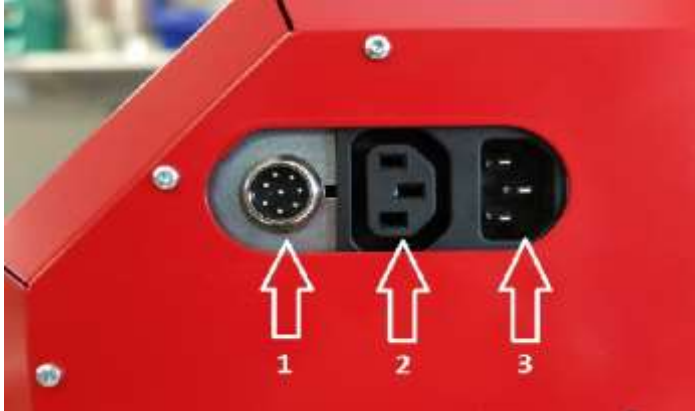

Even the auger engine has a contact device (corresponding to nr 4 in the picture above this text). The protection cover of the burner can not be removed without pulling out all cables from the devices. The cable for supply voltage to the burner shall be connected by authorized electrician via the overheating protection of the boiler. Remaining connections have prepared cabling with connection devices that come with the burner.

N.B.! THE BURNER SHALL ACCORDING TO LAW BE CONNECTED TO AN EXTERNAL OVERHEATING PROTECTION WITH MANUAL RESET.

■ Up start & Settings

At delivery the burner is not adjusted and therefore has to be adjusted with a flue gas instrument at the first start.

1. Fill the feed auger with pellets before it is connected to the burner by connecting the connection cable of the burner to the auger. Let it run for a couple of minutes after it has been filled (approx. 10-15min is recommended). Then run it exactly 10 min in a plastic bag and measure the weight. See figure 1 below. In this case it was 1284 gram at 10 min.= 128 gram / min. This value is entered as shown in Figure 2



Figure 1

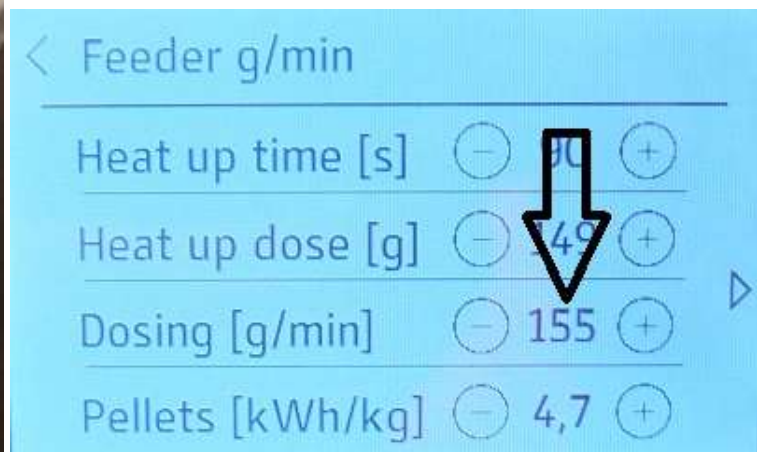

Figure 2

2. Press the right arrow on the display to the next menu in which you confirm the change with OK button. See below Figure 3. This procedure should you do if you change your pellets quality..

Power mode 1 may just be between 6-8 kW.

Power level 5 may only be between 25-30 kW.

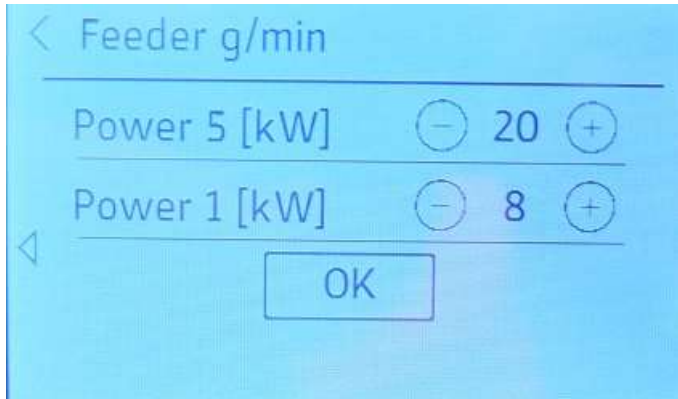

Figure 3

3. To adjust amount of air and fuel for operation the flue gas instrument shall be used. Talk to your installer. Installation of right amount is important to obtain a good firing economy. Adjustment protocol should also be left to the customer in writing.





■ Programming and information



















Touch screen user interface

User Guide



General icons description

ICON	DESCRIPTION	ACTION
	Enter temperature menu	Touch
	Check the current ignition/shutting down state	Touch
	Enter main menu	Touch
	Increase	Touch OR hold









	Decrease	Touch OR hold
	Enter timers menu	Touch
	Enter statistics menu	Touch
	Enter settings menu	Touch
	Enter tips menu	Touch
	Turn ON the heating device	Hold
	Turn OFF the heating device	Hold
	Screen lock set to HIGH	Touch
	Screen lock set to LOW	Touch
	Close the menu	Touch
	Navigate back	Touch
	Previous sub menu page	Touch
	Next sub menu page	Touch
	Info about the selected submenu	Touch
	ON -->enable; OFF --> disable	Touch
	Confirm	Touch
	Delete	Touch
	Start the feeder motor manually (only when the heating device is OFF)	Hold

Idle mode

Fumis Premium automatically switches to idle mode after 30 seconds of inactivity and exits from it when touched again. Depending on the settings for the idle mode, the screen in idle mode displays:

- the clock only
- the WATER temperature only
- Switching between the clock and WATER temperature.
- The state of the heating device (when the heating device is in OFF state)
- Errors/alerts (if present)
- It never switches to idle mode from the service menu.

Setting the date and time

- Touch the screen (if currently in idle mode) to exit from the idle mode. If the display currently is not in idle mode, skip this step.
- Tap on  to enter the temperature menu
- Tap on  to enter the main menu
- Tap on  to enter the settings menu
- Tap on "**Time**" to enter the **Time** menu
- Set up **Hours**, **Minutes** and **Day of the week** by tapping on  and/or  icons. After completing the settings, save them by tapping on .
- Tap on "**Date**" to enter the **Date** menu
- Set up the **Day**, **Month** and **Year** by tapping on  and/or  icons. After completing the settings, save them by tapping on .

Note:

Pay attention in setting up the date and time properly. Otherwise the weekly timers will not perform when desired.

Setting the target temperature

- Set temperature for example. 80 degrees then the burner starts up when it has dropped 15 degrees and modulates the effect when it reaches 80 degrees. Shuts off completely when it reach 82 degrees.

Setting the water temperature

- Touch the screen (if currently in idle mode) to exit from the idle mode. If the display currently is not in idle mode, skip this step.
- Tap on  to enter the temperature menu
- The screen is now displaying the currently set water temperature (WATER temperature):



- Change the target temperature by tapping on  and/or  icons. The changes are saved immediately.

Turning on the heating device

Manually through Fumis Premium

Fumis Premium user interface allows you to turn on the heating device in two different ways (see below "Option A" and "Option B").

Note:



The heating device can be turned on only when its current state is off (the label "OFF" present in the upper left corner of the screen).

- Option A:
- Touch the screen (if currently in idle mode) to exit from the idle mode. If the display currently is not in idle mode, skip this step.
- **Hold** the center of the screen below:

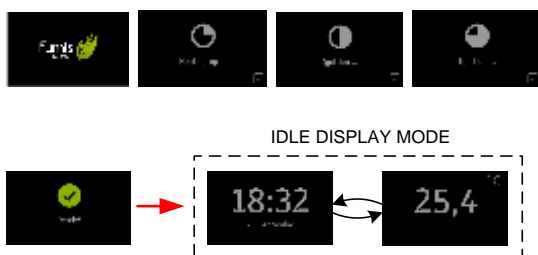

The following screens will appear as follows:



- Option B:
- Touch the screen (if currently in idle mode) to exit from the idle mode. If the display currently is not in idle mode, skip this step.
- Tap on  to enter the temperature menu
- Tap on  to enter the main menu
- **Hold**  to turn on the heating device

The following screens will appear as follows:

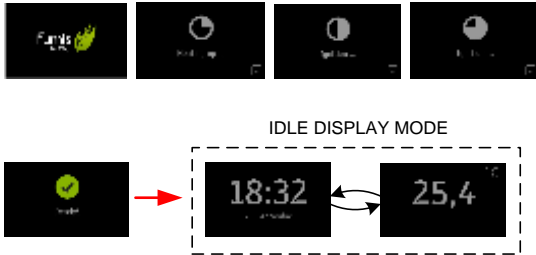

Automatically by Eco Mode

When the temperature rises over the set point, the heating device automatically turns OFF and the screen below appears. It will automatically restart when the temperature falls below the set point (for details see chapter 6.12.).







Note:

If the Eco Mode function is not included in your heating device, this screen will never appear.

Changing/selecting the operating power level

Fumis Premium allows you to switch between 5 different power levels.

- Touch the screen (if currently in idle mode) to exit from the idle mode. If the display currently is not in idle mode, skip this step.
- Tap on  to enter the temperature menu
- Tap on  to enter the main menu
- Increase/decrease the operating power level by tapping on  and/or  icons. The changes are saved immediately.





Note:

The heating power in kilowatts [kW] depends of the heating device and not of the Fumis Premium user interface.

Changing/selecting the ambient fan speed

Fumis Premium allows you to switch between 5 different ambient fan speeds.

If the **"AUTO"** option is selected (the operating power must also be set to **"AUTO"**), the ambient fan speed follows the automatic power modulation of the heating device.

- Touch the screen (if currently in idle mode) to exit from the idle mode. If the display currently is not in idle mode, skip this step.
- Tap on  to enter the temperature menu
- Tap on  to enter the main menu
- Increase/decrease the operating power level by tapping on  and/or  icons. The changes are saved immediately.



Note:

This option is only available in air and/or hydro stoves. In boilers, burners and other types of heating devices the ambient fan is not included.

Viewing service counters

The Fumis controller monitors the combustion system operation and provides different service counters. The values are read-only and cannot be modified.

To see the service counters, follow the steps below:

- Touch the screen (if currently in idle mode) to exit from the idle mode. If the display currently is not in idle mode, skip this step.
- Tap on  to enter the temperature menu
- Tap on  to enter the main menu
- Tap on  to enter the statistics menu



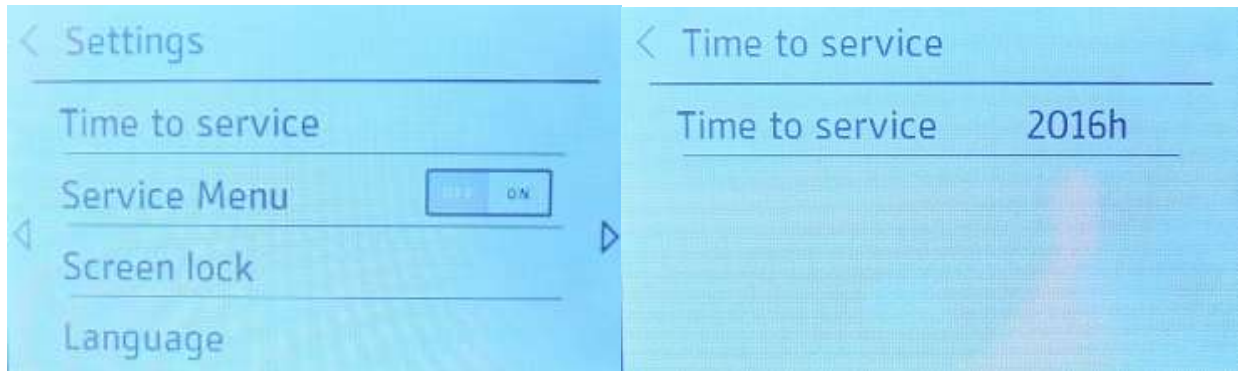

Press the "Time for service" to see how many hours are left until service. When it alarms for service. **It is important that service be performed to maintain warranty.**



Setting the fuel quality

If enabled in your combustion system, Fumis Premium allows you to select up to 3 different qualities for pellets. If you change pellet quality and the ash is getting darker, you can change "Fuel" level to level 1. Standard setting is level 2..

To select the fuel quality, follow the next steps:

- Touch the screen (if currently in idle mode) to exit from the idle mode. If the display currently is not in idle mode, skip this step.
- Tap on  to enter the temperature menu
- Tap on  to enter the main menu
- Tap on  to enter the settings menu
- Tap on **"Fuel"** to enter the **Fuel** menu
- Set the desired fuel quality (for pellets and/or wood logs) by tapping on  and/or  icons. The changes are saved immediately.





Display brightness

Fumis Premium offers different possibilities for setting the display brightness. Thanks to an integrated ambient light sensor, optionally Fumis premium is able also to adapt the display brightness automatically, according to the brightness of the ambient which surrounds it.







Under display settings you are able to:

- Activate the automatic adaptation to the ambient brightness
- Setup the brightness of the display when active
- Setup the brightness of the display when switched to idle mode (after 30 seconds of inactivity)

Setting the automatic brightness adaptation

- Touch the screen (if currently in idle mode) to exit from the idle mode. If the display currently is not in idle mode, skip this step.
- Tap on  to enter the temperature menu
- Tap on  to enter the main menu
- Tap on  to enter the settings menu
- Navigate to the "**Display brightness**" by tapping on  and/or 
- Tap on "**Display brightness**" to enter into the **Display brightness** menu
- Tap on "**Automatic ON/OFF**" icon to activate/disactivate the automatic brightness adaptation

Setting the active display brightness

- Touch the screen (if currently in idle mode) to exit from the idle mode. If the display currently is not in idle mode, skip this step.
- Tap on  to enter the temperature menu
- Tap on  to enter the main menu
- Tap on  to enter the settings menu
- Navigate to the "**Display brightness**" by tapping on  and/or 
- Tap on "**Display brightness**" to enter into the **Display brightness** menu
- Set the desired active display brightness by tapping on  and/or  icons, next to the "**Active bright.**" label. The changes are saved immediately.

Note:







When automatic brightness adaptation is active, this option is disabled.

Setting the idle display brightness

You can increase or decrease the display brightness in the idle mode to conserve energy. As soon as you touch the keyboard, the brightness of the display will increase to default value.

To setup the idle display brightness follow the steps below:

- Touch the screen (if currently in idle mode) to exit from the idle mode. If the display currently is not in idle mode, skip this step.

- Tap on  to enter the temperature menu
- Tap on  to enter the main menu
- Tap on  to enter the settings menu
- Navigate to the "**Display brightness**" by tapping on  and/or 
- Tap on "**Display brightness**" to enter into the **Display brightness** menu
- Set the desired active display brightness by tapping on  and/or  icons, next to the "**Idle bright.**" label. The changes are saved immediately.

Note:

When automatic brightness adaptation is active, this option is disabled.





Enabling the Eco Mode function

When the temperature rises over the set point, the heating device automatically turns OFF and the screen below appears. It will automatically restart when the temperature falls below the set point.

Note:

If the Eco Mode function isn't included in your heating device, skip this chapter.

To enable/disable the Eco Mode function, follow the steps below:

- Touch the screen (if currently in idle mode) to exit from the idle mode. If the display currently is not in idle mode, skip this step.
- Tap on  to enter the temperature menu
- Tap on  to enter the main menu
- Tap on  to enter the settings menu
- Navigate to the "**Temp. offsets**" by tapping on  and/or 
- Tap on "**Temp. offsets**" to enter into the **Temp. offsets** menu
- Activate/deactivate the Eco Mode function by tapping the "**ON/OFF**" icon

After activating the Eco Mode, the heating device will automatically turn ON/OFF according to the temperature set point.

Note:

For detailed description of the Eco Mode function, refer to the user guide of your heating device.

Idle display mode settings

Fumis Premium automatically switches to idle mode after 30 seconds of inactivity and exits from it when touched again. Depending on the settings for the idle mode, the screen in idle mode displays:

- the clock only
- the WATER temperature only
- Switching between the clock and WATER temperature.
- The state of the heating device (when the heating device is in OFF state)
- The fuel autonomy (if enabled in the Fumis Premium and supported by the heating devices software)
- Errors/alerts (if present)

Note:

It never switches to idle mode from the service menu.

To setup the idle display mode settings follow the steps below:

- Touch the screen (if currently in idle mode) to exit from the idle mode. If the display currently is not in idle mode, skip this step.

- Tap on  to enter the temperature menu

- Tap on  to enter the main menu

- Tap on  to enter the settings menu

- Navigate to the "**Display settings**" by tapping on  and/or 

- Tap on "**Idle display mode**" to enter into the **Idle display mode** menu

- Activate the info you want to be displayed in idle mode by tapping the "**ON/OFF**" icon:

Example:

If you want to activate the air temperature monitoring in idle mode, tap on the "**ON/OFF**" icon next to the **Air temp** label.







If you want to activate the water temperature monitoring in idle mode, tap on the "**ON/OFF**" icon next to the **Water temp** label.

If you want to activate the clock monitoring in idle mode, tap on the "**ON/OFF**" icon next to the **Time** label.

Setting the temperature unit (°C/°F)

Fumis Premium allows you to choose between displaying the temperature in °C (degrees Celsius) or in °F (degrees Fahrenheit).







To select the desired temperature unit, follow the steps below:

- Touch the screen (if currently in idle mode) to exit from the idle mode. If the display currently is not in idle mode, skip this step.
- Tap on  to enter the temperature menu
- Tap on  to enter the main menu
- Tap on  to enter the settings menu
- Navigate to the "**Temperature unit**" by tapping on  and/or 
- Tap on "**Temperature unit**" to enter into the **Temperature unit** menu
- Select the desired temperature unit by tapping on  and/or  icons

Setting the speaker volume

Fumis Premium allows you to set the volume of the integrated speaker, or to turn it completely OFF.

To set the desired speaker volume, follow the steps below:







- Touch the screen (if currently in idle mode) to exit from the idle mode. If the display currently is not in idle mode, skip this step.
- Tap on  to enter the temperature menu
- Tap on  to enter the main menu
- Tap on  to enter the settings menu
- Navigate to the "**Speaker volume**" by tapping on  and/or 
- Tap on "**Speaker volume**" to enter into the **Speaker volume** menu
- Set the desired speaker volume, or turn it completely OFF, by tapping on  and/or  icons

Using the manual feeding function

Before turning on your heating device for the first time (or in case you ran out of combustible), the feeder screw may be completely empty and due to this fact the ignition may fail. To avoid this, Fumis premium allows you to refill the feeder screw before starting up or restarting the heating device.

To activate the manual feeding, follow the steps below:

- Touch the screen (if currently in idle mode) to exit from the idle mode. If the display currently is not in idle mode, skip this step.

- Tap on  to enter the temperature menu
- Tap on  to enter the main menu
- Tap on  to enter the settings menu
- Navigate to the "**Manual feed**" by tapping on  and/or 
- Tap on "**Manual feed**" to enter into the **Manual feed** menu
- Activate the manual feeding by **holding** the  icon. After holding the icon for 30 seconds, the manual feeding will be automatically deactivated again. If 30 seconds were not enough to refill the feeder screw, hold the icon again. Repeat it until the first pellets starts to fall into the burning pot.





Note:

The manual feeding option is only available in heating devices which are equipped with a feeder. The manual feeding during the operation of the heating device cannot be activated. If your heating device is equipped with a pressure safety switch, simultaneously with the feeder, the combustion fan will also be activated.

Checking the time to service

Fumis Premium allows you to check the time when you should contact the service personnel to perform regular maintenance on your combustion system. This value is read-only and can be modified by authorised personnel only.

To check the time to service, follow the steps below:

- Touch the screen (if currently in idle mode) to exit from the idle mode. If the display currently is not in idle mode, skip this step.
- Tap on  to enter the temperature menu
- Tap on  to enter the main menu
- Tap on  to enter the settings menu
- Navigate to the "**Timo to service**" by tapping on  and/or 
- Tap on "**Timo to service**" to see the remaining **Time to service**

Note:

When the time to service expires, the Fumis Premium warns you by displaying the A002 alert (Call service for regular maintenance). The heating device is still operational. To reset this alert, call authorised personnel. If your heating device does not require regular maintenance, the **Time to service** option is skipped in the settings menu.

Using the screen lock function

Fumis Premium allows you to lock the screen in order to prevent accidental changes of the settings. With the screen lock enabled, you can navigate the menu to display current values, but you cannot edit any of the settings, except the screen lock itself. Note that this option does not disable the Fumis IR (Infra Red) remote control. The screen lock setting offers the following options:

OFF: the screen lock is disabled, all functions are available





Lo: impossible to change settings, only possible to turn ON/OFF the heating device. When this option is selected, the black  icon appears in idle screen and main menu screen.

Hi: all the functions are locked (also turning ON/OFF the heating device), only return to **Lo** or **OFF** option is enabled). When this option is selected, the red  icon appears in idle screen and main menu screen.

Tip

We recommend you use the screen lock option if children are able to access the keyboard without adult supervision.

To use the screen lock function, follow the steps below:



- Touch the screen (if currently in idle mode) to exit from the idle mode. If the display currently is not in idle mode, skip this step.
- Tap on  to enter the temperature menu
- Tap on  to enter the main menu
- Tap on  to enter the settings menu
- Navigate to the "**Screen lock**" by tapping on  and/or 
- Tap on "**Screen lock**" to switch between **screen lock - OFF**, **screen lock - Lo** and **screen lock - Hi**.



Using the display cleaning function

Fumis Premium includes a functionality, which makes the display inactive for 30 seconds. This allows you to clean the display easier (if needed), because you prevent accidental changes to the settings.

If the default 30 seconds are not enough to clean the display, you can reactivate the "**Display cleaning**" function.

To use the display cleaning function, follow the steps below:

- Touch the screen (if currently in idle mode) to exit from the idle mode. If the display currently isn't in idle mode, skip this step.
- Tap on  to enter the temperature menu
- Tap on  to enter the main menu

- Tap on  to enter the settings menu
- Navigate to the "**Display cleaning**" by tapping on  and/or 
- Tap on "**Display cleaning**" to enter into the **Display cleaning** menu
- Tap on "**START**" icon to start the 30 seconds countdown

Note







If the heating device turns on automatically (by timer, room thermostat, etc.), the cleaning function gets interrupted in the moment when the heating device turns ON.

The display cleaning function cannot be activated during the operation of the heating device.

Setting the language



Fumis Premium allows you to choose between different languages.



To set the desired language, follow the steps below:

- Touch the screen (if currently in idle mode) to exit from the idle mode. If the display currently is not in idle mode, skip this step.
- Tap on  to enter the temperature menu
- Tap on  to enter the main menu
- Tap on  to enter the settings menu
- Navigate to the "**Language**" by tapping on  and/or 
- Tap on "**Language**" to enter into the **Language** menu
- Navigate to the **desired language** by tapping on  and/or 
- Tap on the language you want to select. The change is saved immediately and appears in the upper left corner of the screen.

Checking the firmware version





To check the version of the firmware currently installed on the Fumis controller and Fumis Premium user interface, follow the steps below:

- Touch the screen (if currently in idle mode) to exit from the idle mode. If the display currently is not in idle mode, skip this step.
- Tap on  to enter the temperature menu
- Tap on  to enter the main menu

- Tap on  to enter the settings menu
- Navigate to the "**Info**" by tapping on  and/or 
- Tap on "**Info**" to see the currently installed firmware.

Using the tips

For easier usage of the Fumis Premium you can make use of the tips

- Touch the screen (if currently in idle mode) to exit from the idle mode. If the display currently is not in idle mode, skip this step.
- Tap on  to enter the temperature menu
- Tap on  to enter the main menu
- Tap on  to enter the settings menu
- Navigate to the "**Tips**" by tapping on  and/or 
- Tap on "**Tips**" to enter into the "**Tips**" menu
- Tap on the tip you want to view

- Troubleshooting

The Fumis Premium provides notifications and warnings for alerts and errors, which can occur when using the heating device.

In case of an alert, the Fumis Premium warns you by displaying the alerts description in yellow, while in case of an error, its description is displayed in red.

In case of an alert, the combustion system is still operational, in case of an error the combustion system is seriously malfunctioning and the service personnel should be contacted. Each alert and error also has a code, which can be used to identify the problem.

o Alerts and errors

Alert/error code	Alert/error description	Label on the screen
A004	Low battery	Low battery, call service for its replacement.

E004	MB communication error	MB communication error
E101	Fire error	Error, caused by: 1. Ignition failed, 2. water over temperature, 3. backfire protection
E108	Security switch error	Overheated. Clean the boiler and chimney. Reset the alarm and restart the device. If the error persists, call service.
E110	NTC1	Sensor connected to T02 malfunctioned or disconnected. Call service.
E114	No pellets	Fuel Ignition timeout expired (empty the burning pot and restart the device) or fuel tank empty (refuel the tank).

○ Resetting the alerts and errors

▪ Resetting the alerts

In case of an alert, the screen displays a yellow message with the alerts description (see an example below).

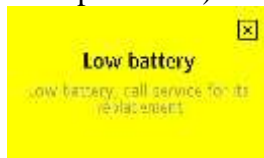

To close the alert screen, tap on . Closing the alert screen does not reset the alert. After closing the alert screen with , the alert code is still present in the upper left corner of the main screen as well as on all idle mode screens (see an example below).

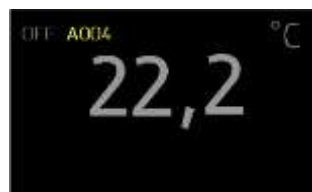

To see the alert message again, tap on the alert code in the upper left corner, in this example **A004**. To reset the alert, the issue must be solved. In this example, the battery must be replaced.



Note:

In case of an alert, the heating device is still operational (in some cases has limited functions).

▪ Resetting the errors

In case of an error, the screen displays a red message with the errors description (see an example below).



To close the error screen, tap on . Closing the error screen does not reset the error. After closing the error screen with , the error code is still present in the upper left corner of the main screen as well as on all idle mode screens (see an example below).



To see the error message again, tap on the error code in the upper left corner, in this example . To reset the error, the issue must be solved. Until this, the heating device is not operational.

Note:

In case of an error, the heating device is not operational until the repairs are made.

Maintenance of the burner

How many times as necessary to clean manually due to the quality of pellets and how much energy the house consumes.

Because a dirty boiler gives higher flue gas temperatures and thus lower efficiency. At least twice a year, the burner is taken apart and the outer burner tube is separated from the inside, ashes are being collected and sinter to be removed.

Check the colour of ashes in the boiler smoke gas tubes. Should be gray to light brown. Is the colour black, the burner must be adjusted, otherwise it shorten the life of the burner. Contact dealer for adjustment of the burner.

Follow the instructions for manually cleaning

Cleaning of roster

1. Loosen all 3 cables to the burner.
2. Demount the burner cover and then carefully pull the cover backwards.
3. Loosen the quick-action hooks that hold the outer pipe towards the back cover. Carefully separate the burner.
4. See pictures below for cleaning.
5. Re-mount in reverse order.

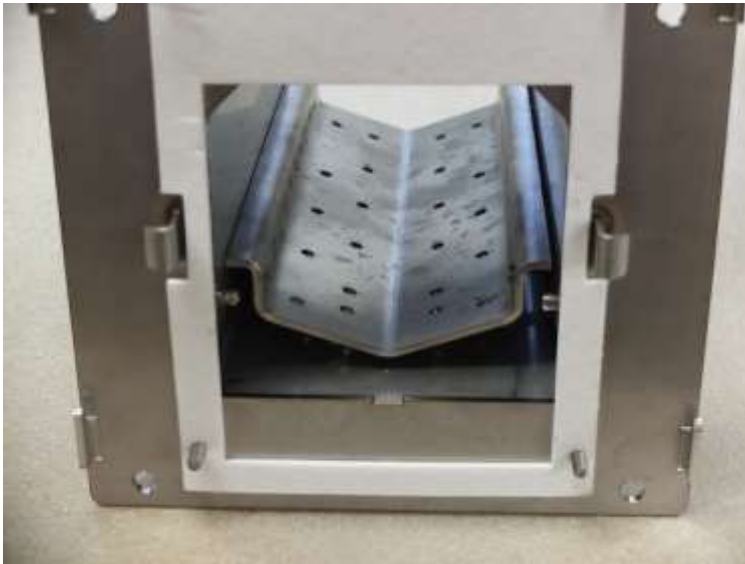

Remove the grate for cleaning



Remove the grate backwards

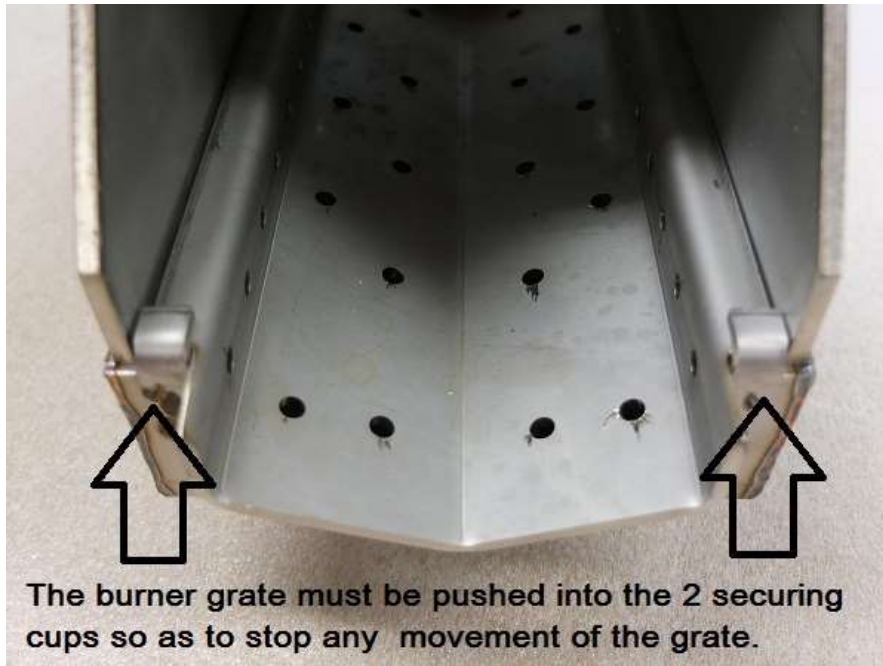

Change of ignition element

1. Loosen all 3 cables to the burner.
2. Demount the burner cover and then carefully pull the cover backwards.
3. Loosen the quick-action hooks that hold the outer pipe towards the back cover. Carefully separate the burner.
4. Loosen the screw that holds the ignition element and pull out the element from its position.
5. Loosen the ignition units connections on the terminal block.
6. Re-mount in reverse order.

Change of flame guard (orange)

1. Loosen all 3 cables to the burner.
2. Demount the burner cover and then carefully pull the cover backwards.
3. Loosen the connection cables on the control system (black) and pull out the giver from its hole.
4. Re-mount in reverse order.

■ Wiring diagram

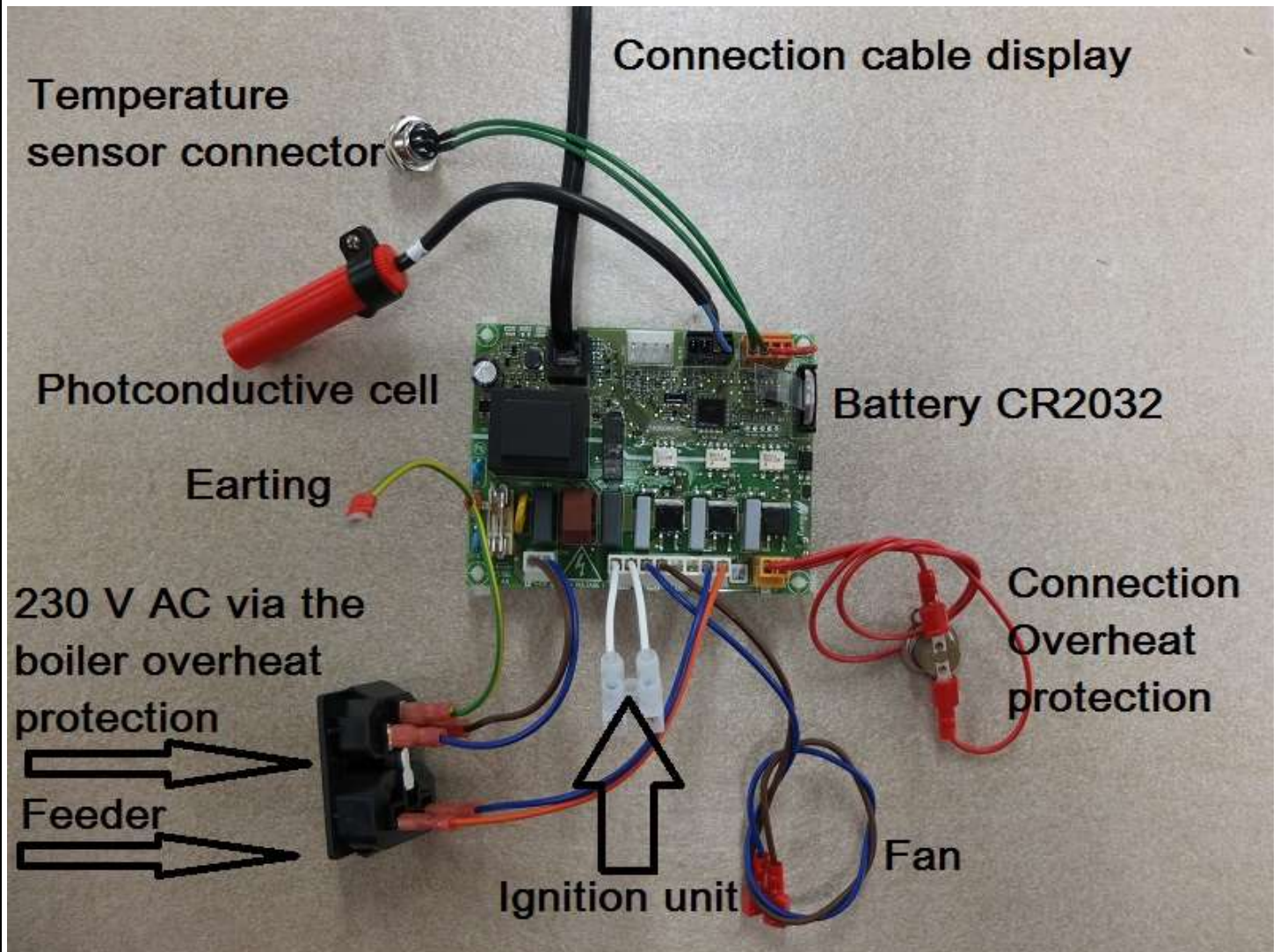

Drawing

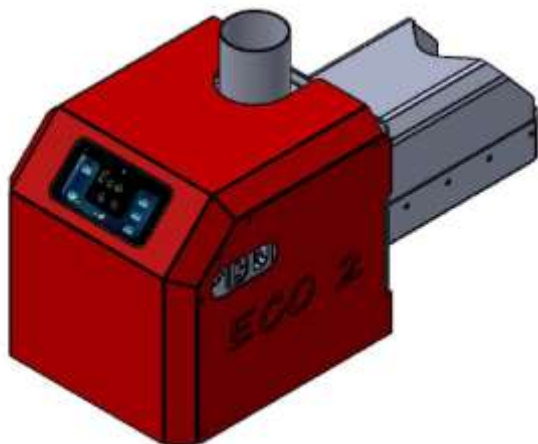
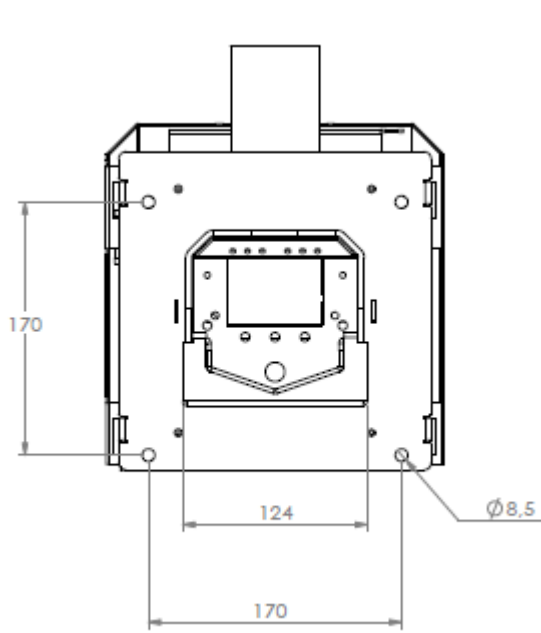
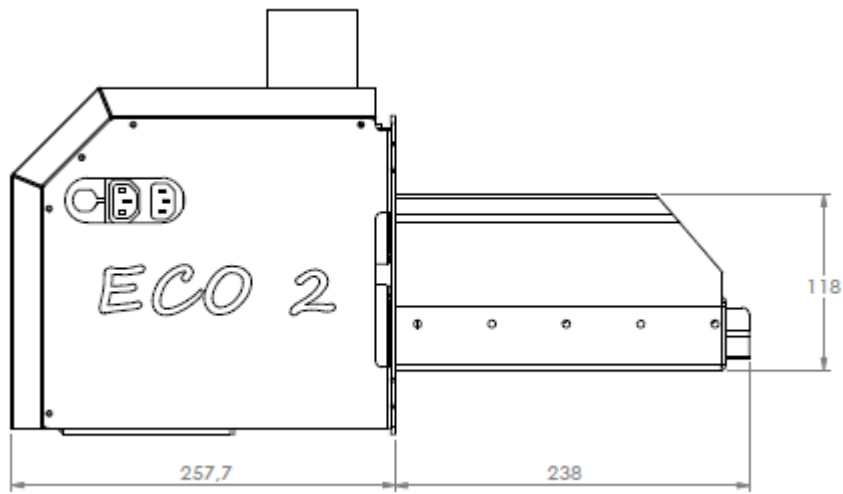

■ Data and Service information

Safety regulations

The product is CE-marked which means that it fulfills all prescribed requirements that exist to put the product into work within the EU. ULMA AB disclaims all responsibility that could occur at misuse or wrong use of the Ulma2000TCA burner.

Technical data

Measurement outside boiler (wxhxd)	227mm x 233mm x 258 mm
Measurement chamberunit (diameter x length)	125 x 220 mm
Combustion efficiency	Approx. 97 %
Given effect at maximum level	30 kW
Tension	230 VAC
Effect consumption (average during operation)	Approx. 100 W
Weight	10 kg
Warranty (see warranty parts)	1 year

Fittings

Overheating protection to the boiler.
Fuel storage.

■ Warranty conditions

ULMA AB leaves a 1 year warranty on the Ulma ECO 2 pellet burner regarding fabrication faults on ingoing components. (Ignition unit 5 year)

The exception are damages caused by lack of maintenance, incorrect handling or deficient installation. The warranty does not cover damages on persons or other property other than the sold product, not other consequential damages or indirect occurred damages. Working costs to change components are not included in the warranty. Ulma AB provides new components at return of defective components within 3 weeks. Components sent with receiver freight will not be gotten out.

Provided that an authorized installer has mounted or inspected the burner and that warranty/installation certificate has been sent to ULMA AB no later than 2 weeks after installation.

Yearly service should be made and service reports should be able to be shown at possible complaint.

Otherwise no warranties are valid.

If the retailer has a service agreement with the customer ULMA AB covers the working costs.

The retailer is liable to inform the customer this.

We reserve us the right to construction changes and dissent us from possible printing errors.

■ Information to the installer

The installation certificates at the end of this manual shall be filled out with correct information. One to the customer that should be kept in this binder. The other one we would like you to send per mail to ULMA AB. We also prefer that you enclose a print from the flue gas analysis with date and time of the installation. For you who do not have access to a printer to your flue gas instrument we ask you to fill out the information in the installation certificate per hand. If this is not being followed we refer to the warranty conditions what regulations that are valid. If you mishandle this you are also removed from retailer system and you can no longer sell, install our products. If you use a different dosage auger brand we would like you to contact us at installation.

Adress information:

ULMA AB

Energigatan 11

SE – 512 53 Svenljunga, SWEDEN

Phone: +46 (0)325-17680

Webb site: www.ulma.se

E-mail: info@ulma.se

■ Test record

Date: _____

Model: _____

Serial number: _____



Checkpoints

1. Connection and tension setting
2. Programming
3. Functional inspection photo-conductive cell
4. Functional inspection temperature sender
5. Start up of burner: control of ignition unit + screw engine exit
6. Functional inspection fan
7. Serial no
8. Control of content in packaging

Pellet burner
Manual
Kit with mounting set
Fall hose

Checked and approved by: _____

Name: _____

Installation certificate ULMA ECO 2 Premium 30 kW *(customer copy)*

Customer Information:

Installer / Retailer:

Name:	Company:
Adress:	Adress:
Post code:	Post code:
City:	City:
Phone:	Phone:

Signature of the installer:

Date:

Type of product	Type designation	Serial number	Year of production
Pellet burner	ULMA ECO 2		
Boiler			

Check list:

Measured screw capacity Gram at 10 Min.

Have a longer auger been chosen:

Yes No (Give length:.....meters)

Control of storage / pellets feeding. *(The way of the fuel).*

Control of the hose between and feed auger, burner unit, fall shaft, break door in burner.

Menu setting burner:screw G / Min.

Chosen power level: 1. _____kW 2. _____Kw

NOTE ! Perform test before draft stabilizer.
Printout from flue-gas test result.
High power (8-10% O2)
Low power.(Must be over 10% O2)

Protocol:

Effect mode	Draught - hPa	O2%	CO ppm	CO2%	Flue gas temp	Effect burner (kW)
High						
Low						

Give fuel deliverer at the service occasion.
Bulk, small bags, other etc.

If this instruction is not being followed at installation, operation and maintenance ULMA AB is according to existing warranty conditions not bounded.

Installation certificate ULMA ECO 2 Premium 30 kW (Mailed to ULMA AB in SVENLJUNGA, SWEDEN)

Customer Information:

Installer / Retailer:

Name:	Company:
Adress:	Adress:
Post code:	Post code:
City:	City:
Phone:	Phone:

Signature of the installer:

Date:

Type of product	Type designation	Serial number	Year of production
Pellet burner	ULMA ECO 2		
Boiler			

Check list:

Measured screw capacity Gram at 10 Min.

Have a longer auger been chosen:

Yes No (Give length:.....meters)

Control of storage / pellets feeding. *(The way of the fuel).*

Control of the hose between burner and feed auger,

burner unit, fall shaft, break door in burner.

Menu setting burner:screw G / Min.

Chosen power level: 1. _____ kW 5. _____ kW

NOTE ! Perform test before draft stabilizer.
Printout from flue-gas test result.
High power (8-10% O2)
Low power. (Must be over 10% O2)

Protocol:

Effect mode	Draught - hPa	O2%	CO ppm	CO2%	Flue gas temp	Effect burner (kW)
High						
Low						

Give fuel deliverer at the service occasion. Bulk, small bags, other etc.	
--	--

If this instruction is not being followed at installation, operation and maintenance ULMA AB is according to existing warranty conditions not bounded